

Dedicated to the memory of Renzo Boscoli.

This article, for me, marked the beginning of the journey down the road of Low Energy Transmutations (L.E.T.).

Following a discussion I had with Renzo Boscoli concerning his “Note on Thermonuclear Fusion”, which led to the decision to prepare a new version of his “Note”, I spoke of my perplexities regarding the Atom Models currently accepted, and of the need for a radical revision of such Models. His answer was to stand up and, with a conspiratory smile, move towards one of the bookcases which completely covered the walls of his office, which was in an old colonial house just a few kilometres outside Bologna.

He picked up four volumes, which he handed to me saying “Read them and tell me what you think”.

They were all Italian editions of : 1) *L'evoluzione Cosmica (Cosmic Evolution)* by H. P. Blavatski (1888); 2) *Prove in Geologia e Fisica delle Trasmutazioni a Debole Energia (Geological and Physical Studies on Low Energy Transmutations)* by C. L. Kervan (1983); 3) *Prove in Biologia delle Trasmutazioni a Debole Energia (Biological Studies on Low Energy Transmutations)* by C. L. Kervan (1986); 4) *Il Tesoro degli Alchimisti (Alchemists and Gold)* by J. Sadoul (1972).

I read all four volumes quickly and was astonished. The two texts by Kervan especially left no shadow of doubt. The enormous bulk of experimental data documented by Kervan led to a single conclusion: “accepted” Atomical Physics were completely wrong. I thus decided to start a *Historical Critical Analysis of the Atom Models*, which I concluded in

1988 with the publication of *Sea Green* No. 7, Unpublished No. 12, Autumn 1988. In 1989 I drew from this work “A Brief History of the Atom, Cold Fusion and Cold Fission”. After *Historical Analysis of the Atom Models*, I moved straight onto “The Reconstruction of the Periodic Table (The Alchemist’s Dream)”, published in *Seagreen* N. 8, Spring 1989, p.53.

At the same time the story of “Cold Fusion” by Fleischmann and Pons started. From 1989 to 1990 I completed my preliminary research on Cold Fusion with the Fusion:



On 19th April 1991 the article “Cold Fusion and Cold Fission: Experimental Evidence for the Alpha Extendel Model of the Atom” was ready, and I presented it at the ICCF-2 in Como, Italy.

Finally, in 1992, J. O’M. Bockris invited me to Texas A & M University to participate in some experimental testing, where I found it easy to recognise the Alchemic matrix.

Roberto A. Monti

Renzo Boscoli

Roberto A. Monti  
Researcher  
IASFBO.INAF.IT  
E-mail: ramonti45@gmail.com

Gerardina A. Cesarano Monti  
Research Assistant  
E-mail: gerardinacesarano@hotmail.com

### **The cryogenic model of nuclear fusion.**

“When temperature decreases, it becomes radiant”. All of this hints at something else: it shows that the ancients were aware of something which puts many present-day scientists, especially astronomers, to shame; the reason behind the ignition of matter, the paradox of heat produced by refrigerating contractions and other similar cosmic enigmas. For this shows us, without any doubt, that the ancients had knowledge of such phenomena. (*H.P. Blavatsky, Cosmic evolution, 1888*).

Introduction by Roberto Monti (Spring 1987).

Following the series of articles which I worked on over the last three years, I now consider the case with Albert Einstein closed.

The current situation is as follows:

As regards the first postulate on the Theory of Special Relativity, there is ample empirical evidence against the hypothesis  $\sigma_0 = 0$  and in favour of the idea of a static universe (see work by Hubble, Nernst, Aaronson, La Violette, etc.) [1]

With regard to the second postulate of the S.R. Theory ( $c_0 = c_M$ ), every doubt has been resolved concerning the necessity of an experimental verification, never actually undertaken since the time it was first enunciated.

As far as the Theory of General Relativity is concerned, I have brought to light inconsistencies within the so-called *equivalence principle*, likewise for the so-called *experimental verification* of the G.R. Theory. [2].

Recently, there has finally been a confirmation of the possible discrepancy of 10% between the Einsteinian hypothesis of the independence of the electromagnetic force due to velocity (verified up to the present-day as “approximately 10%” [3] and the experimental data regarding the acceleration of electrons in the electromagnetic field [4]; while after further assessment, the Laplace hypothesis on the velocity of the gravitational interaction ( $v_g \gg c_0$ ) has validity.

Putting Einstein to one side, just as I was thinking of testing out my Principles, especially the inverted relative proportion between force and interaction velocity [6], I was presented with a pamphlet entitled “**Note on “thermo-nuclear” fusion**” [7].

When asked what I thought? Excellent!

I contacted the author, Renzo Boscoli, immediately; we met the following day.

He made me think about a science-fiction short story I had read as a young boy: “Atom man” [8].

It has been a pleasure working with him on the writing of this new version of his “Note”.

**On the current state of solar physics.**

In the Introduction and Summary to “Physics of the sun” [9] after having observed that in light of new data from satellites, the current model of solar aureole radiance does not hold, P.A. Sturrock highlights the fact that it has always lacked a valid convection theory with the aim of a coherent analysis of the internal structure of stars. In addition he writes, “more recently, we have learned from SMM data that one of the fundamental ‘constants’ of solar-terrestrial physics is not a constant: the solar luminosity has been found to vary on a time-scale of one day. It also poses new and difficult questions concerning the propagation and storage of energy through the convection zone” [10].

He continues affirming that *“in recent years confidence in our understanding of stellar interiors has been profoundly shaken by the conflict between the actual measurement of the neutrino flux from the Sun and theoretical estimates of this flux”*; and reports P.D. Mac D. Parker’s conclusion, according to whom: *“the observation of solar neutrinos is a crucial test of our understanding of the solar interior, and until we can understand the disagreement between the current model predictions and the current experimental results, we are forced to conclude that after 50 years we still have only circumstantial and indirect evidence fro thermonuclear reactions in the solar interior.”* [10].

Furthermore, he brings to our attention the fact that the plasma of the sun’s internal core “does not seem to satisfy the conditions essential for the applicability of current theories on collisions in a plasma, and this fact reopens the debate on the validity of the calculations of the reaction speed of the (hypothesised) thermonuclear reactions” [10].

Lastly, he brings to our attention that “another important enigma relative to the internal structure of the sun is the state of rotation of the core”; that is to say, the hypothesis “of the possible existence of a high rotational speed of the core associated to strong magnetic fields” [10].

We would like to add to these observations made by Sturrock, by saying that in effect it is not difficult, *per se*, to understand the existence of the sun, the *official* one, **but rather how it was formed.**

In other words: it is not entirely clear how, in a space which is not within confines of sorts, gravity can continually amass a protostellar gas. At the same time, this gas allows the temperature to rise without reaching, in a short amount of time, a thermal-gravitational equilibrium, which would prevent any further growth of the gas itself.

And at this point, there is enough not only to authorize attempts to reintroduce discrepant data in the fiftieth anniversary of the *via thermonuclear methods* (two amusing examples can be found in “*Physics of the sun*” [11]), but also to authorize research into new *methods* for a fusion which is not necessarily thermonuclear.

### **The Ranque Effect.**

In 1933 the French physicist Georges Ranque discovered that by circulating an air mass in a space contained within circular walls (a tube), a vortex was created, composed of a nucleus of cold air surrounded by an annular band of hot air [12].

This phenomenon, even if a physical explanation is still to be found, has nevertheless been fully verified experimentally.

Moreover, it is a fact that we consider it to be a fundamental principle for a different theory of convection. And the *Principle* is as follows:

**A mass of gas, regardless its density and initial temperature, which has one or more possible causes, either exogenous or endogenous, if placed in axial rotation, will cool the closer it is to the axis of rotation, and will warm up in the external area.**

Confirmation of this principle can be found on various levels.

For example, in meteorology it can explain the formation of hail: if, because of contrasting winds, two layers of air move against each other at slightly different speeds, horizontal vortexes form in the area of friction in between the two layers. At the centre of these vortexes there is such a fall in temperature (caused by the Ranque effect) that the drops of water freeze, or at least water vapour condenses and deep-freezes around solid nuclei, made of suspended dust particles.

These ice nuclei continue to rotate and, over time, increase in quantity, growing at the expense of the surrounding frozen atmospheric dust, like confetti in a drum mixer. The combined action of the wind and the rotation (Magnus effect [13]) increases their weight until it exceeds the supporting force, and makes them fall to the ground.

This hypothesis is enough to explain not only the spheroidal growth of the hailstones in concentric layers, but moreover the gradient of internal temperature (e.g. from  $-25^{\circ}\text{C}$  to  $0^{\circ}\text{C}$ ).

We would just like to quickly remind you that a comet is also a kind of large hailstone.

Let's now consider a mass of cosmic gas.

If at a precise moment in time this mass of gas (which can contain dust particles distributed more or less uniformly, but is mainly made up of hydrogen), for one or

several concurrent reasons, begins to rotate around an ideal axis, it will have to take on the form of a rotational ellipsoid due to its fast rotational speed.

Even in this case we can suppose that the Ranque effect will be felt, so much so that the **centre** will cool and the periphery of the ellipsoid will warm up.

Central cooling is definitely a possible way for gravity to allow gassy material to flow towards the central zone without the system's increase in kinetic energy obstructing, which would contrast the gravitational action.

This way, with the Ranque effect ever persistent, the central matter can continue its thermal descent towards absolute zero, as is also supported by Kepler's third law. This is because during the thickening process the molecules on the ray orbits become increasingly smaller and therefore, rotate ever more quickly, intensifying the Ranque effect itself. We can therefore say that within our rotating nebula of hydrogen and dust particles, its density continues to increase in correspondence to the areas closest the centre. Furthermore, as it exceeds, in its descent, the critical temperature (33 °K), the gas itself begins to liquefy, further reducing its volume, until it forms, in the centre of the cosmic nebula, a cold, compact spheroidal core, which is first liquid and then even solid.

Let's pause here a moment to take a closer look at the objects which are commonly identified as examples of protostars.

As can be observed, it goes from Bok globules [14] (temperature 10 °K) to objects such as IRAS 16293-2422, "an extremely cold infrared source, with temperatures from 20 to 39 °K and a bolometric luminosity of 23L" [15].



Ok. This is how we see it: collapse occurs in the Bok globule until it becomes an object such as IRAS 16293-2422, the heat emitted from the central nucleus reminds us of the hot air emitted by a refrigerator..obviously due to the Ranque Effect.

Here we can easily imagine the increase of this protosolar core, becoming ever colder, first liquid and then even solid in its bowels. This will continue until the increasing internal pressure, due to the weight of the overhanging layers, will lead to the first plausible and possible nuclear reaction, which obviously will not be the proton-proton chain.

### Brief note on the proton-proton chain.

The proton-proton chain is represented as follows [16]:

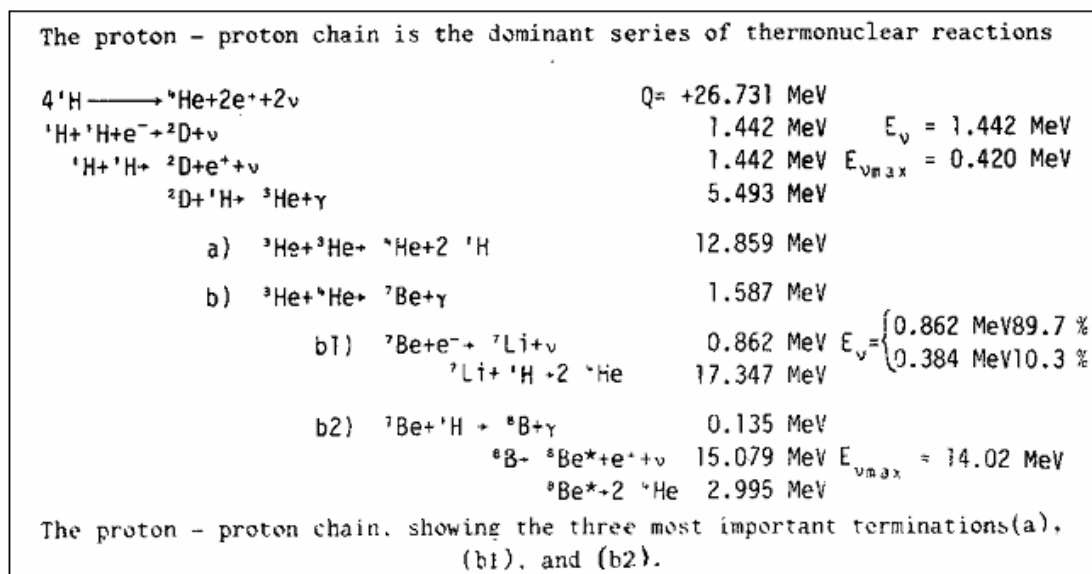

For us the most significant aspects of this chain are the following:

- I) The starting point is (even though well-hidden) **the synthesis of the neutron** (stars are, in fact, first of all, **neutron factories**).

- II) Even if it represents the starting point of the proton-proton chain, the neutron, after its synthesis, disappears, or at the very least **never explicitly appears** as an essential element in the fusion process.
- III) All the reactions in the chain are represented as **esoenergetic**, while experience shows that a complex chain of reactions is generally made up of an opportune mixture of **endoenergetic** and **esoenergetic** reactions.

These are the reasons why the proton-proton chain leaves us feeling perplexed.

But now let's return to our protosolar core.

### **The “cryogenic” model of nuclear fusion.**

Let's begin: the first nuclear reaction possible inside the protosolar core, at a temperature of almost/nearing absolute zero, is one which is possible at the expense of the neutral hydrogen atoms, gravitational collapse (or “K Capture” [17]):

There are two ways it can be written in:

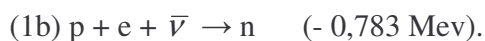
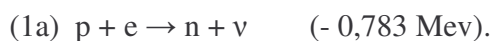

Let's now compare it to the proton-proton chain.

In the latter there is: production of a neutrino of 1,442 Mev in the first branch; in the second branch, the production of antimatter (positron) and a corresponding decrease in the energy of the neutrino (0.42 Mev).

In (1a), on the other hand, the quasi-totality of gravitational and Coulomb energy is *absorbed* by the increased mass of the ultra-cold neutron [18] (the neutron formed as a

result of the *collapse* has a mass superior to the sum of the mass of the proton and the electron). We can therefore hypothesise the production of a low-energy neutrino.

In (1b), there is **the absorption of the antineutrino** (which acts like a catalyst of the “gravitational collapse”) and, once again, the synthesis of the ultra-cold neutron. This is, without a doubt, less likely, but **not** improbable (remember that it constitutes the inverse reaction of the decay of the neutron).

Therefore, because protosolar neutrons are born at practically zero energy ( $<10^{-7}$  ev), **it is precisely because of their extremely low speed** (few metres per second) that they are in the ideal conditions (in the hypothesis of the relation of inverse proportionality between reactivity and particle speed) [6] to react with the hydrogen in the immediate vicinity of the collapse area.

Therefore, the second of the possible reactions is the following [19]:

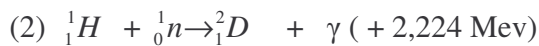

which could be followed by:



But obviously, not all the neutrons produced in the core can be subjected to two captures as shown above. As they wander among the neutral hydrogen atoms, many of these will reach the end of their existence before having been able to react with one of the surrounding nuclei. In which case, for the inverse (1b) (decay of the neutron) they will be able to produce protons, electrons and antineutrinos in peculiar conditions of reactivity.

Specifically, the protons will be born at a shorter distance to the tritium nuclei, with which they can react according to [20]:



or even according to the following:



Likewise, Helium-3, can absorb a neutron, transforming it into Helium-4 and freeing energy according to the reaction;



As well as the rising (so-to-speak) nucleosynthetic reactions already explored, almost all the reactions basically characterized by the emission of energy in the form of electromagnetic waves (gamma rays), decreasing reactions have to be taken into consideration. That is to say nuclear disintegration of the deuterium atom [21] as a result of freed radiation in the other reactions:

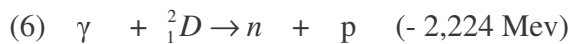

This important reaction is the inverse of (2) and when it takes place, prolongs the life of the free neutron, virtually, in time and space. This regenerates the neutron, for example, in its most external position, within the thermal areas or between them; or between these and the photosphere, or in the same one, or even, in the solar corona. The exact same effect happens with reaction (4). One can observe that both (4) and (6), where neutrons are emitted, are examples of endoenergetic reactions, as in (1) (neutron synthesis). While all the reactions where there is the absorption of neutrons, are esoenergetic.

As regards the speed and energy of the neutrons, correlated with the density of the neutron gas (understood to be the average number of neutrons per unit of volume), it must be clear that from the moment of their birth and throughout their existence as such, that is to say free, the neutrons gradually warm up. This is as a result of the effect of the reactions in which they are involved, and of the *ambient* effect (kinetic) of the areas with

a high energy content, which they cross as they distance themselves from the core where they were produced until the photosphere (Ranque Effect). This is where most of the neutrons complete their mission (that of exchanging kinetic energy or as nuclear reagents).

It is obvious further still, were reactions (4) and (6) (as we have seen these virtually prolong the life of the neutron) not to happen, the neutrons actually produced in the core would be unlikely to reach the photosphere intact.

Now let's summarize the reactions we have just listed, along with their energy balances in the following table:

**Table for the “cryogenic” model of nuclear fusion.**

Esoenergetic reactions	Endoenergetic reactions
	$p + e \rightarrow n + \nu$ (-0,783 Mev) (1a) $p + e + \bar{\nu} \rightarrow n$ (-0,783 Mev) (1b)
(2) $p + n \rightarrow D + \gamma$ (+2,224 Mev)	$p + e \rightarrow n + \nu$ (-0,783 Mev) (1a) $p + e + \bar{\nu} \rightarrow n$ (-0,783 Mev) (1b)
(3) $D + n \rightarrow T + \gamma$ (+6,239 Mev)	$p + e \rightarrow n + \nu$ (-0,783 Mev) (1a) $p + e + \bar{\nu} \rightarrow n$ (-0,783 Mev) (1b)
(2) $p + n \rightarrow D + \gamma$ (+2,224 Mev)	$\gamma + D \rightarrow n + p$ (-2,224 Mev) (6)
(5) ${}^3_2\text{He} + n \rightarrow {}^3_2\text{He} + \gamma$ (+20,589 Mev)	${}^3_1\text{T} + p \rightarrow {}^3_2\text{He} + n$ (-0,765 Mev) (4) return in cycle

**Total energy (emitted and absorbed).**

+ 31,276 Mev

- 5,338 Mev

**Total.**

+ 25,938 Mev

If we eliminate the common terms to the left and to the right of the  $\rightarrow$  symbol in these 9 equations, we get the simplified expression:

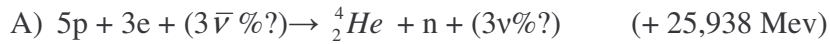

However, proceeding analogously with the Bethe cycle (p-p chain) as we have seen, we obtain: B)  $4\text{p} \rightarrow {}^4_2\text{He} + 2\text{e}^+ + 2\nu$  (+ 26,731 Mev)

At present we are no way able to specify the probability of the reactions (1a) and (1b), which regulate the production of neutrons and the absorption of antineutrons respectively. Although it may be difficult to imagine what happens when a neutral hydrogen atom implodes in something one hundred thousand times smaller (the neutron), we nevertheless believe that the neutrinos emitted from the core are likely to be of low-energy, at least with regards the neutrinos in the proton-proton chain. Whereas high-energy neutrinos may well result from nuclear reactions in “thermal areas” beyond the core itself.

Lastly, we would like to remind that: 1) The problem of *missing neutrinos* is due to the fact that the proton-proton chain produces **high-energy** neutrinos, which are 3 to 4 times higher than that observed. 2) The experiment:  ${}^{37}\text{Cl} + \nu \rightarrow {}^{37}\text{Ar} + \text{e}$

strictly depends on the temperature, which has forced theorists to hypothesise the most diverse mechanisms in order to decrease the temperature at the centre of the sun. As confirmed by M.J. Newman, these mechanisms “*have not yet proved to be convincing*”. 3)

At present, research is being done on experimental methods to measure the component of low energy in the solar neutrinos spectrum. [22].

Therefore, as things currently stand, there is, as always, only a need for further experimental data.

## A MODEL FOR THE INTERNAL STRUCTURE OF THE SUN (figure 1).

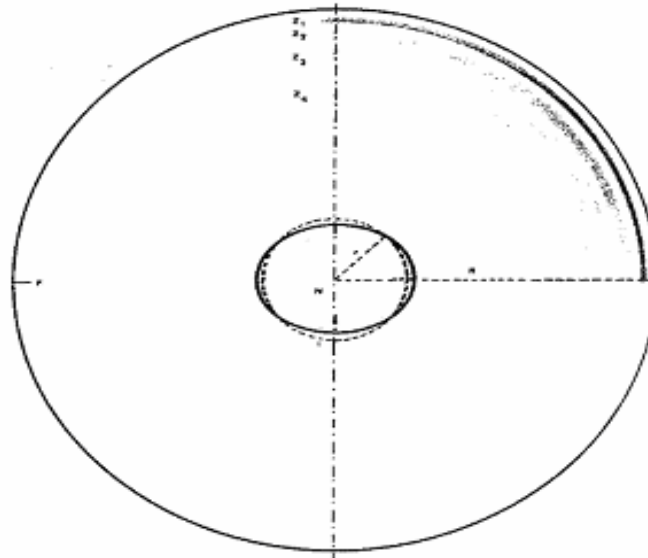

**Fig. 1 – Schematic model of the interior of the sun according to the formulated hypothesis in this note on nuclear fusion.**

The average ray ( $r$ ) of the SOLAR CORE (N) and the solar ray (R) are, in the diagram, approximately an average proportion of 1:5. The core N is a rotational ellipsoid, whose levelling represented in the diagram is only indicative. The total mass of the Sun is practically all contained in the one core. In contrast, the overall mass of the PHOTOSPHERE (F) and of the THERMAL ZONES ( $Z_1, Z_2, Z_3, Z_4, \dots$ ) is insignificant. Four of these have been drawn with a purely explanatory aim. This is because it was not possible to determine confidently the number, nor the thickness, nor their consistency, nor their reciprocal distances, nor their temperatures (except in the case of  $Z_1$ ), nor each of their single periods of rotation in proportion to the corresponding average values attributable to the photosphere. Still with regards the hypothesis of the solar mass concentrated in the core, a piece of data which is more attainable is that which is supplied by the calculation relative to the period of rotation of the core itself, which works out to be approximately 43 hours. Likewise, an estimate of the core's dimensions suggests its *average* diameter is between 250,000 and 300,000 km, which in turn must correspond to an average density of just over 200 times the density of water, and a peripheral rotational speed of approximately 6 km per second. Let's now consider the internal *temperatures* of the Sun, starting from values close to absolute zero in the most internal area of the core, where neutrons are continually generated by the gravitational collapse of neutral hydrogen; these must gradually increase from interior towards the exterior, passing through median values in the thermal zones, until eventually reaching the highest ones in the photosphere (approx. 6,000 K).

According to the model of the Sun presented here, sunspots are thin rips in the fiery veil (approx. 1,500 km) of the photosphere; and it is through these that one can catch a glimpse of the first thermal zone ( $Z_1$ ), whose temperature should not exceed 4,000 + 4,500 K. Finally, the formidable flow of gamma and neutron radiation emitted by the core, and the Ransge Effect (which manifests itself inside the thermal zone itself) ensure that this radiation is thermally protected from one another, and from the imminent photosphere, therefore without any significant heat exchange from the periphery towards the Sun's interior.

As far as we can tell, this model does not contradict any of the data currently observable [23].

a) First of all, the ellipsoidal structure of the core explains the *unexplainable* difference in the precession of the perihelion of Mercury [24].

b) Similarly, a solar core which is not a sphere but a rotational ellipsoid, has a much faster gravitational drag on the equatorial region in the thermal and photospherical regions, than on the polar region. From this there is a simple explanation of the rotational difference of the sun: the photosphere at the equator is closer to the core than at the poles, and because of a greater attraction it must rotate faster. In this model the sun which we see is but a slender spherical halo of rarefied gases, which is kept at a distance from central core and kept *turned on* like phosphorus in a fluorescent lamp, from the high level of radiation emanating from the core.

c) As regards the sunspots and the reason why they appear darker, or colder, in light of this model the explanation of the rest of the photosphere is somewhat insignificant: despite all the hypotheses, including those still being done, on their nature, the sunspots **are what they seem to be:** holes in the photosphere. And, when looking through these holes, we see *something darker*, this means that this something is colder than what is above it: it is a well-known fact that it is exactly 2000-2500 °K *colder* than in the photosphere [25]. There are still some more aspects of this model of the sun to be explored, those being the origin of the solar magnetic field, supposing that the most internal region of the core acts like a metallic superconductor (remember that from a chemical point of point, hydrogen is a metal), with all the possible electric, magnetic and electromagnetic implications.



**d)** Concerning the distribution of gaseous, rarefied and ionised material found in the space between the core and the photosphere, as we have already seen, one can hypothesise it exists in layers; in distinct, confined concentric regions near the photosphere, which are due to the effect of the core's radioactive pressure. These *thermal regions* probably started to differ following their global formation, that is to say, after the start of the core's nuclear activity. This is where there are secondary, thermal phenomena which are caused by neutron synthesis and subsequent nuclear reactions. Between these thermal regions (the last one being the photosphere which we can see) and the core, there must be a space which is practically *completely void of matter*, populated almost exclusively by the intense flux of neutrons and gamma radiation coming from the core itself.

The sunspots allow us to know that the temperature of the thermal region directly below the photosphere is in the region of 4000-4500 °K. On the other hand, it is difficult, if not impossible, to calculate the number of remaining thermal regions, their rotational periods and temperature.

Let us recap. Starting from the bottom, each of the thermal regions has to protect itself from the heat of the next region. This is due in part to the Ranque effect, but especially to the intense radioactive flow which blows incessantly, which progresses towards the exterior as solar wind, from the sun's core to the surrounding cosmic space.

With regards the core, please refer to fig. 1.

**e)** Finally, in a discontinuous model of the sun, like the one which has just been described, where the central nucleus continuously *blows* a radioactive flow spherically towards the exterior, against an orbiting photosphere, itself also discontinuous, which is made up of a

myriad of *granules*, one can hypothesise that the orbital motion of the photosphere around the core has to undergo spherical and radial disturbances. This is due to the effect of the radiation flow from below.

In other words, a sun such as the one proposed, should swell and deflate alternately: that is to say, each solar granule should behave like a ping-pong ball supported by a vertical jet of air (like those at Luna Park).

As everyone knows, the ball oscillates up and down, and by regulating the diameter of the nozzle, the air pressure which comes out, etc., one can make the oscillating period more or less constant.

And, as is well-known, the radial pulsations of the sun are by now, an unquestionable fact.

**Another note, this time on the A, H, N bombs.**

The *classic* model of the sun immediately made physicists think of obtaining power from *controlled* nuclear fusion reactions, and of following the *heat route*: to carry out **thermonuclear** reactions.

It is precisely because the H bomb, the first of these attempts, was resolved *positively*, that **thermonuclear** energy came to be considered the right way forwards: it was only a question of “**controlling the H bomb a bit better**”.

An H bomb is essentially an A bomb *surrounded* by a wall of light nuclei (for example a mixture of deuterium and tritium).

The explosion of the A bomb, which according to this point of view, is the trigger of the H bomb, almost instantaneously generates an enormous quantity of heat. According to the **thermonuclear** hypothesis, this heat is needed to give the light nuclei essential

energy so that they may merge, and overcome the electrostatic repulsion which tends to keep them separated.

One of the reactions which are most taken into account is the following [26]:



Now, as is known, when the A bomb explodes other than creating heat, there is also a sudden, enormous wave of neutrons and gamma rays.

Nevertheless it is thought that the fusion in the H bomb is caused by the heat in the A bomb, whereas the neutrons and gamma rays are, first of all, an effect of fission and then of fusion.

Until now, it seems that we have only *made the most of the secondary* effect of the explosion of the A bomb – the *wave* of neutrons and gamma rays – for military reasons: the production of the *N bomb*.

However, based on what we have just seen, one can put forward the hypothesis that the heat is the **effect**, and not the cause, of fusion.

In other words: the *real* trigger of the H bomb is not the A bomb, but the N bomb.

And recapping the fusion reactions previously listed, one can hypothesise the following *fusion chain*:

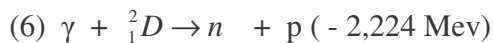

(photodisintegration of deuterium)

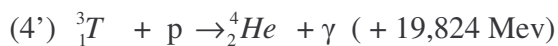

The energy balance of the two reactions (6) and (4') is 17.6 Mev; exactly the same as that of reaction (7) between deuterium and tritium, a reaction which can be obtained from the sum of (6) and (4'):

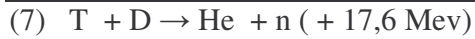
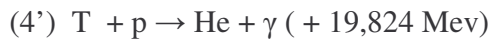
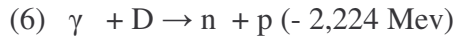

Furthermore, in the H bomb blast there are obviously more than just the two reactions mentioned above. The first is triggered by gamma rays coming from the A bomb blast, whereas the second produces more gamma radiation than is consumed in the first one.

In fact, when the neutrons from both (6) and the A bomb blast in turn react with the deuterium – reaction (3) – regenerate the tritium consumed in (4) and provide more gamma radiation for the reacting system.

In practice, for technical reasons, when constructing an H bomb, it is better to borrow tritium in its nascent state starting with a Lithium isotope, Lithium 6, presumably as  ${}^6\text{LiD}$  according to the reaction:

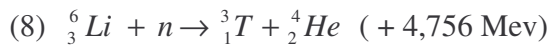

Therefore, according to this point of view, starting with the A bomb, we have the following sequence/cycle:

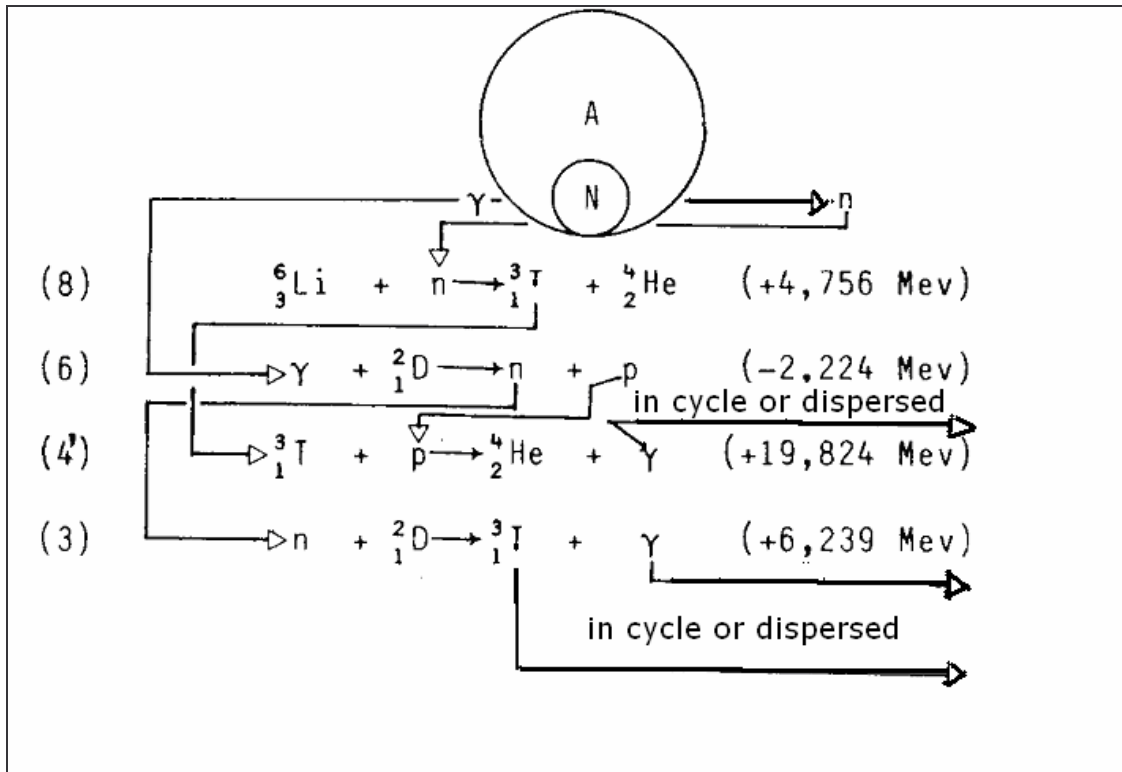

In total:

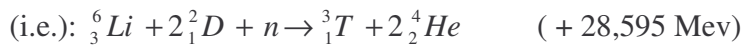
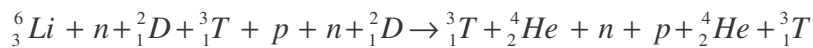

In practice however, only a part of the products from reactions (4') and (3) go back into the cycle.

This is because the heat produced by the A bomb and intensified in the H – even if, in this hypothesis, represents not the cause of the explosion, but the **effect**, - nevertheless performs an action which is hardly insignificant: **to stabilise and moderate** fusion reactions.

In other words, **it is precisely because of the heat** that the overall mass of the nuclear fuel will end up expanding itself and being dispersed until all the phenomenon has disappeared.



neutrons it would have been necessary to also produce Helium-3, **of which no trace had been found.**

As a consequence, in the ZETA device, **there must have been a different reaction to the desired one.**

Now, taking into account the fact that the plasma of deuterium which they had wanted to melt was certainly made up of a blend of deuterium and free electrons; and because of its unusual structural characteristics, the ZETA device could have functioned like a Betatron. The most probable hypothesis is that, as a result of its *anomalous* behaviour (compared to its thinkers' project), ZETA functioned like Betatron, emitting gamma rays energetic enough ( $h\nu > 2,224 \text{ Mev}$ ) to trigger deuteron photodisintegration within the deuterium plasma as shown in reaction (6).

As we have seen, this is the first step towards fusion, for whose completion, reaction (4) would have needed to be triggered; to obtain this the following elements are needed... nascent proton, Tritium, also nascent... which is in fact missing in the ZETA doughnut.

But even if there had been some Tritium, there is a strong possibility that controlled fusion would not have been achieved **because the temperature of the plasma was too high:** in other words, in the case of *cryogenic fusion*, the heat created has to be immediately removed analogously as should be done (even if it is for the opposite reasons) in a fission reactor.

And at this point, after having quickly reminded you that Fermi's successes in the field of fission were brought about by his happy idea to cool neutrons; it was also **his idea** (1945) to produce ultra-cold neutrons, *to put in a bottle* in order to venture into the low-energy region (a region where "*there is as much to learn as in the region which is to be found*

between the highest energy so far obtained, and infinity" J.G. King [18]), let's move on and examine two possible *cryogenic* methods for controlled nuclear fusion.

### “Cryogenic” methods for controlled nuclear fusion.

Fundamentally, it involves working at room temperature and at a pressure of 100 Tor: a) Subjecting the nuclear fuel (for example deuteriate of lithium-6) to the combined action of the neutrons and the gamma rays of energy superior to 2,224 Mev, according to the following chart:

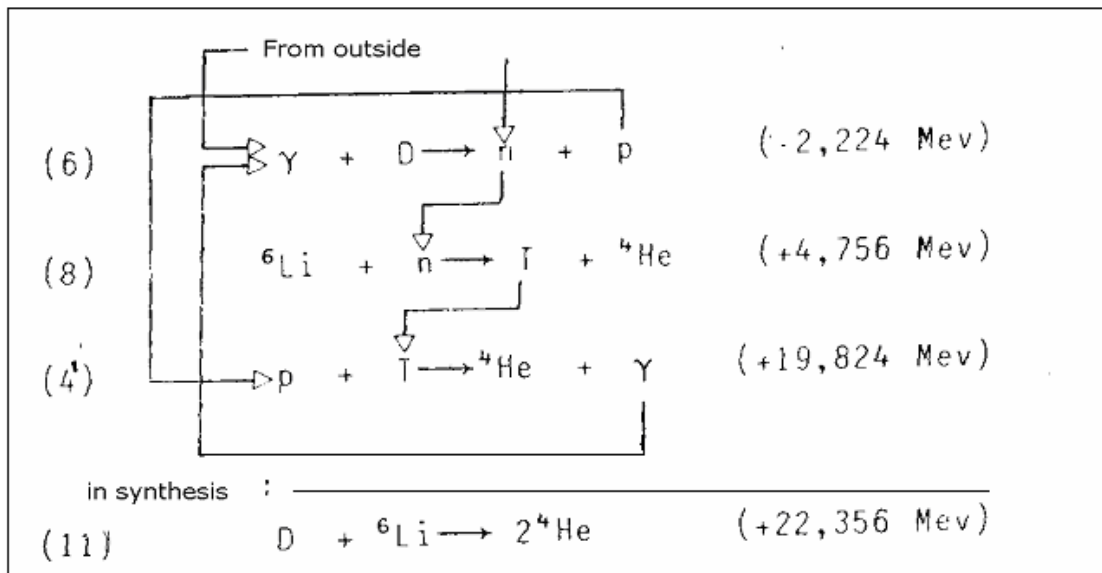

Theoretically speaking, once triggered, the deuteron photodisintegration reaction, which is carried out by the gamma rays, should continue by itself and should increase. In practice however, once the fusion process is triggered, to also compensate for inevitable leaks it would perhaps be necessary to supply the nuclear fuel with an adequate dose of neutrons and gamma rays, both of which controlled with suitable moderators and/or screens.



b) Since it is not possible to exclude before-hand whether reactions (6), (8) and (4') are able to result in a chain reaction, even of an explosive nature, it would perhaps be better to invert the process.

In an area where one can *direct* gamma rays and neutrons in a continuous flow, it might be possible to send in some deuterium, while the Lithium-6 could be present in various forms; as dust particles, as a liquid, as a vapour or even as an integral part (involucrum) of the reactor itself.

Furthermore, it is not strictly necessary to resort to the Lithium-6 isotope as it is already possible to obtain tritium from the Lithium-7 isotope. This is according to a reaction which is endoenergetic and which, unlike (8), restores the incident neutron:

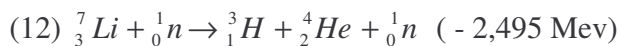

Now, since Lithium-7 and Lithium-6 are the two natural isotopes of Lithium, contained, respectively, in the proportion of 92.58% and 7.42% (Li-6), it appears that it may still be useful to use natural Lithium, bypassing the expensive process of preliminary separation of the two isotopes, even if this substitution (bearing in mind the proportion Li-7/Li-6) costs an energetic sacrifice measurable in 6.7 Mev.

Therefore, it is a project which is quite easy to formulate, and obviously not as simple to achieve. But the implementation of the experiments indicated does not entail technical difficulties superior to those related to the Tokamak or Laser reactors; compared to these, these proposals seem to us to benefit from the indisputable advantage of low cost, in terms of both time and money.

Furthermore, both proposed methodologies could be experimented *in parallel* with already-existing projects: the first **a**), for example, in the field of Laser Reactors; the second **b**), in the field of toroidal accumulation rings of ultra-cold neutrons.

That's enough for now.

### **Concluding observation.**

Before concluding, however, we would like to make a final observation.

As a consequence of the temporal limits of our existence, we are used to favouring *production* of high-yielding energy cycles (*motors*).

Cycles which go from hot to cold, supplying us with **a lot of work in a short time**.

Research on the Ranque effect, for example, was neglected because the Ranque refrigeration cycle was a low-yielding cycle compared to those already available [28].

However, all that we know about the great natural cycles shows us that the Universe follows a different logic to ours: the great natural cycles are low-yielding cycles.

To clarify: **little work in an infinite amount of time**.

On the basis of this observation, and of the *cryogenic* model, we can therefore state, or at least hypothesise, that, unlike ours, “**the engine of the Universe is not heat, but cold**”.

**Bibliography and note.**

- [1] R. Monti. Seagreen N° 1, P. 68; N° 2, P. 61; N° 3, P. 101; N° 4, P.32.
- [2] R. Monti. Seagreen N° 1, P. 70; N° 3, P.88.
- [3] W. Bertozzi. Am. J. Phys. 32. 551. (1964).
- [4] V. Kose. Physicalisch Technische Bundesanstalt. Private communication.
- [5] R. Monti. Seagreen N° 3, P.90.
- [6] R. Monti. Seagreen N° 3, P. 88-90.
- [7] R. Boscoli. Note on “thermonuclear” fusion. June 1984. Graphic studio S. Matteo. S. Matteo della Decima (Bo).
- [8] M. Leinster. Urania N° 217, Mondadori 1959.
- [9] P.A. Sturrock; T.E. Holzer; D.M. Mihalas; R.K. Ulrich. Physics of the sun. D. Reidel Publishing Co. 1986.
- [10] P.A. Sturrock. Physics of the sun. Vol. I, P. 1-14.
- [11] M.J. Newman. Physics of the sun. Vol. II, P. 33.
- [12] A. Marino. Il tubo Ranque (The Ranque tube). In : Le tecnica dei frigoriferi (The technique of the refrigerators). Hoepli Milano 1953, P. 545; C.L. Stong. Tubo a vortice (Vortex tube) by Hilsch. In: Lo scienziato dilettante (The amateur scientist). Sansoni Editore 1960; E. Bonauguri. Il tubo di Hilsch-Ranque (The Hilsch-Ranque tube). EST Mondadori, Vol. V, P. 307. 1963.

As we can notice, the first citation of the Ranque Effect is in 1953. In the second, in 1960, there is no more trace/evidence (“The origin of the dispositive is not clear. It is said that the principle which it is based on was discovered by a Frenchman who had left some experimental prototypes on the course accomplished by the German army, when France

was under occupation. These examples were taken to a German physicist called Rudolph Hilsch, who was working on refrigerating dispositives at low temperature, needed for Germany's war effort". C.L. Stong. Op. Cit. P. 685). The last one, from 1963, speaks of the "*Hilsch-Ranque tube*".

As far we have been able to find out until now, the story goes something like this:

Ranque's discovery in 1933 raised extreme interest. Especially in Germany. In 1939 the Germans did not just "happen" to pass by Ranque's laboratory. They went there on purpose (was Hilsch also there?). They packed his laboratory down to the last bolt and took it to Germany. There was no more trace of Ranque.

Possible hypotheses: 1) Ranque was already dead. 2) He was killed. 3) He was elsewhere (conscripted?). 4) He was alive but had managed to escape. 5) He had also been "sent".

At the end of the war, when the allies were dividing all the German scientists, Hilsch and his "tube" fell to the United States Marine Corps (C.L. Stong. Op. Cit. P. 684). At the time Ranque must have already been dead, in some way to be established.

There can be no other reason why, after the war, he did not "*make his existence known*" to reclaim his laboratory and priority on his discovery.

We are trying to find out what happened to Georges Ranque. For now, without results, but the inquest is ongoing.

**Addendum** (2007) . In 1989 one of the readers of Seagreen sent me a letter asking if the Georges Ranque I was looking for was the author of "The Philosopher Stone" (La Pierre Philosophale . Paris, 1972). In this way I learnt that up to 1971 Georges Ranque was still alive and working (R. A. Monti).

- [13] H.G. Magnus (1802 – 1870). See: G. Castelfranchi. *Fisica sperimentale e applicata* (Applied and experimental physics). Vol. I P. 396 (1943).
- [14] P. Maffei. *L'universo nel tempo* (The universe in time). Mondadori 1982, P.39.
- [15] C.K. Walker; C.J. Lada; E.T.Young; P.R. Maloney; B.A. Wilking. *Ap.J.* 309, L47-L51. 1<sup>st</sup> October, 1986.
- [16] P.D. Mac D. Parker. *Physics of the sun*. Vol. I, P.21
- [17] E. Segre. *Nuclei e particelle* (Nuclei and particles). Zanichelli 1986, P. 343.
- [18] R. Golub; W. Mampe; J.M. Pendlebury; P. Ageron. *Neutroni ultrafreddi* (Ultra-cold neutrons). *Le Scienze* N° 132, P.66. August 1979.
- [19] L.R.B.Elton. *Introductory nuclear theory*. Pitman 1959, P.205; E.Segre. *Nuclei e particelle* (Nuclei and particles). P. 417.
- [20] E. Amaldi. *Encyclopaedia of the 1900s*. Vol. IV, P. 768.
- [21] E.Segre. *Nuclei e particelle* (Nuclei and particles). P.421.
- [22] M.J. Newman. *Physics of the sun*. Vol. III, P. 33-35.
- [23] G. Godoli. *Il sole* (The sun). Einaudi 1982, P. 185.
- [24] R. Monti. *Seagreen* N° 3. P. 90.
- [25] P. Bakulin; E. Kononovic; V. Moroz. *Astronomia generale* (General astronomy). Ed. Riuniti 1984, P. 292.
- [26] E. Segre. *Nuclei e particelle* (Nuclei and particles). P. 292.
- [27] “Hanno ricostruito il sole” (“They have reconstructed the sun”). *Domenica* (Sunday) del *Corriere*. First term 1958.
- [28] C. L. Stong. *Lo scienziato dilettante* (The amateur scientist), P. 685.